



# Simply Unique Single Seat

## Alfa Laval Unique SSV Tank Outlet

### Concept

The Unique Single Seat Tank Outlet valve meets the highest demands of your process in terms of hygiene and safety. Built on the well-proven Unique SSV platform it is suitable for a wide field of applications, e.g. as a shut-off version closing up against the tank or as a reverse acting valve opening into the tank.

### Working principle

The valve is a pneumatic seat valve in a hygienic and modular design remote-controlled by means of compressed air. It has few and simple moveable parts which results in a very reliable valve and low maintenance cost.

### Standard design

The Unique SSV Tank Outlet valve comes in a one body configuration, which can be delivered with or without a tank flange. The valve features an optimized life span of the seals through a defined compression design. The actuator is connected to the valve body using a yoke and all components are assembled with clamp rings. The body can be turned in any position if the clamps are slightly loosened. The tank flange is welded directly into the tank.



### TECHNICAL DATA

#### Temperature

Max. product pressure in tank: 1000 kPa (10 bar) if max. 20°C  
 . . . . . 850 kPa (8.5 bar) if max. 100°C  
 . . . . . 750 kPa (7.5 bar) if max. 150°C  
 Temperature range: . . . . . 10°C to +140°C (EPDM)

#### Pressure

Max. product pressure in pipeline: . . . . . 1000 kPa (10 bar)  
 Min. product pressure: . . . . . Full vacuum  
 Air pressure: . . . . . 500 to 700 kPa (5 to 7 bar)

### Valve Body Combinations

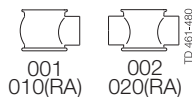

### PHYSICAL DATA

#### Materials

Product wetted steel parts: . . . . . 1.4404 (316L)  
 Other steel parts . . . . . 1.4301 (304)  
 External surface finish . . . . . Semi-bright (blasted)  
 Internal surface finish . . . . . Bright (polished), Ra < 0.8 µm  
 Other product wetted seals: . . . . . EPDM  
 Other seals . . . . . NBR

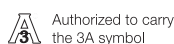

## Options

- A. Male parts or clamp liners in accordance with required standard.
- B. Weld ends or connection types other than Tri-Clamp
- C. Control and Indication: IndiTop, ThinkTop or ThinkTop Basic.
- D. Product wetted seals in HNBR or FPM.
- E. Plug seals HNBR, FPM or TR2 plug (floating PTFE design).
- F. High pressure actuator.
- G. Long stroke actuator (not available for Reverse Acting version).
- H. Maintainable actuator.
- I. External surface finish bright.

## Note!

For further details, see instruction ESE00305.

## Dimensions (mm)

Size	51 mm	63.5 mm	76.1 mm	101.6 mm	DN 50	DN 65	DN 80	DN 100
A <sub>1</sub>	426	439	479	503	429	445	487	506
A <sub>2</sub>	393	406	446	470	396	412	454	473
A <sub>3</sub>	368	381	416	440	371	387	424	443
A <sub>4</sub>	390	403	443	467	393	409	451	470
A <sub>5</sub>	364	377	412	436	367	383	420	439
C	30	30	30	30	30	30	30	30
OD	51	63.5	76.1	101.6	53	70	85	104
ID	47.8	60.3	72.9	97.6	50	66	81	100
t	1.6	1.6	1.6	2	1.5	2	2	2
E	61	81	86	119	62	82	87	120
E <sub>1</sub>	67	73	79	92	68	76	84	93
F <sub>1</sub>	25	25	30	30	25	25	30	30
F <sub>2</sub>	26	26	31	31	26	26	31	31
H	114.9	114.9	154.3	154.3	114.9	114.9	154.3	154.3
J	148	163	178	198	148	163	178	198
S	16	16	21	21	16	16	21	21
M/ISO clamp	21	21	21	21	-	-	-	-
M/DIN clamp	-	-	-	-	21	28	28	28
M/DIN male	-	-	-	-	23	25	25	30
M/SMS male	20	24	24	35	-	-	-	-
Weight (kg)								
Standard	7.1	8.3	13.3	15.9	7.1	8.5	13.8	15.9
Reverse Acting	7.2	8.4	13.5	16.1	7.2	8.6	14	16

A<sub>1</sub>= min. Installation measure to allow that valve can be lifted out of the tank flange / valve body (if Indication Unit is mounted, height must be added)

<sup>1)</sup> For exact A<sub>1</sub> - A<sub>4</sub> dimensions, please refer to informations in Anytime configurator.

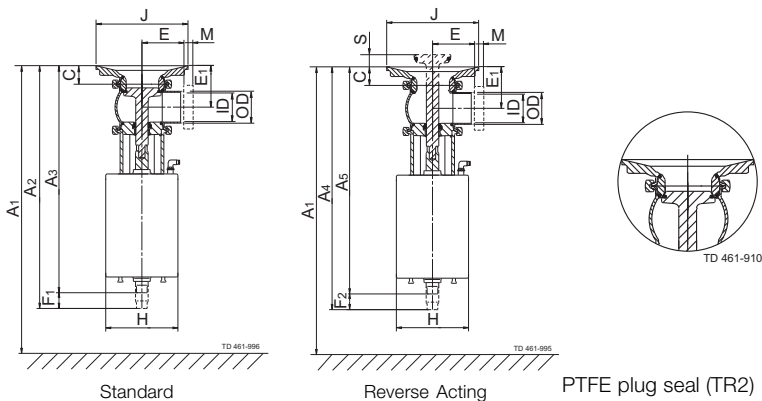

## Please note!

Opening/closing time will be affected by the following:

- The air supply (air pressure).
- The length and dimensions of the air hoses.
- Number of valves connected to the same air hose.
- Use of single solenoid valve for serial connected air actuator functions.
- Product pressure.

## Air Connections Compressed air:

R 1/8" (BSP), internal thread.

## Actuator function

### Air consumption (litres free air) for one stroke

DN50-65 DN/ OD 51-63.5 mm	DN80100 DN/ OD 76.1101.6 mm
0.5 x air pressure [bar]	1.3 x air pressure [bar]

## Other valves in the same basic design

The valve range includes several purpose built valves. Below are some of the valve models available, though please use the Alfa Laval computer aided selection tool (Anytime configurator) for full access to all models and options.

- Reverse acting valve.
- Long stroke valve.
- Manually operated valve.
- Aseptic valve.
- Tangential valve.

The actuator comes with a 5 years warranty

## Pressure drop/capacity diagrams

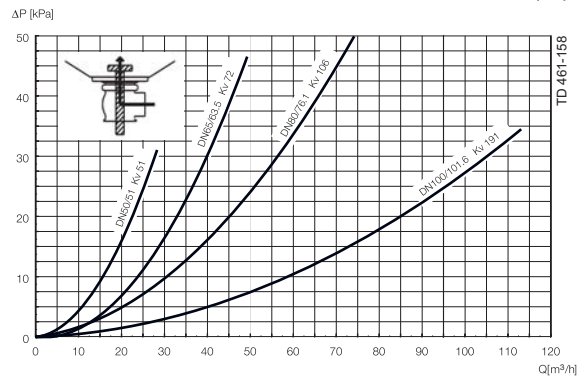
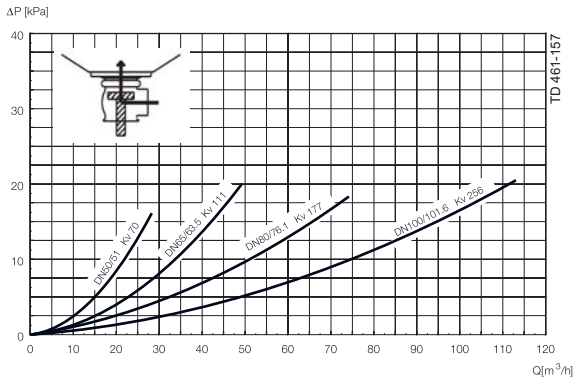
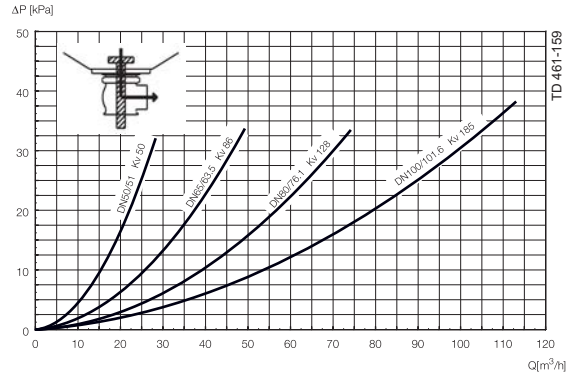
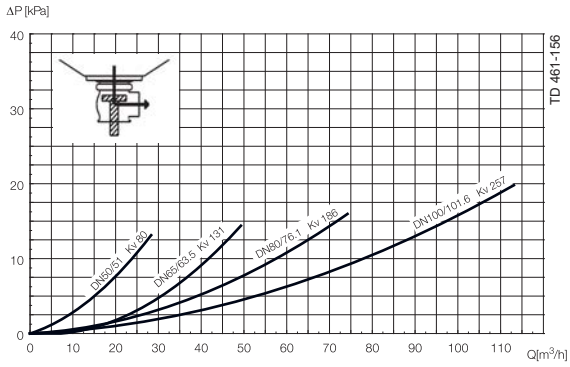

### Note!

For the diagrams the following applies:  
Medium: Water (20°C)

Measurement: In accordance with VDI2173

Pressure drop can also be calculated in Anytime configurator.

Pressure drop can also be calculated with the following formula:

$$Q = K_v \times \sqrt{\Delta p}$$

Where

Q = Flow in m<sup>3</sup>/h.

K<sub>v</sub> = m<sup>3</sup>/h at a pressure drop of 1 bar (see table above).

Δ p = Pressure drop in bar over the valve.

Where

Q = Flow in m<sup>3</sup>/h.

K<sub>v</sub> = m<sup>3</sup>/h at a pressure drop of 1 bar (see table above).

Δ p = Pressure drop in bar over the valve.

2.5" shut-off valve, where K<sub>v</sub> = 111 (See table above).

$$Q = K_v \times \sqrt{\Delta p}$$

$$40 = 111 \times \sqrt{\Delta p}$$

$$\Delta p = \left(\frac{40}{111}\right)^2 = 0.13 \text{ bar}$$

(This is approx. the same pressure drop by reading the y-axis above)

Pressure data for Unique Single Seat Valve Tank Outlet

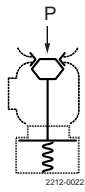

1

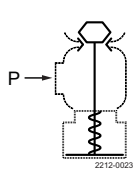

2

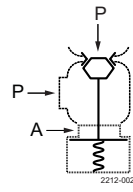

3

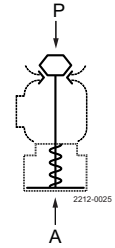

4

A = Air

P= Product pressure

Table 1 - Shut fully closed.

Max. pressure in bar without leakage at the valve seat

Actuator / Valve body combination and direction of pressure	Valve size			
	DN50 DN/OD	DN 65 DN/OD	DN 80 DN/OD	DN 100 DN/OD
	51 mm	63.5 mm	76.1 mm	101.6 mm
1	7.2	4.2	6.4	4.2
2	8.4	4.5	6.8	4.4

Table 2

Max. pressure in bar against which the valve can open

Actuator / Valve body combination and direction of pressure	Air pressure (bar)	Valve size			
		DN50 DN/OD	DN 65 DN/OD	DN 80 DN/OD	DN 100 DN/OD
		51 mm	63.5 mm	76.1 mm	101.6 mm
3	6	10.0	9.0	10.0	6.9
4	6	10.0	8.3	9.9	6.6

Alfa Laval reserves the right to change specifications without prior notification. ALFA LAVAL is a trademark registered and owned by Alfa Laval Corporate AB.

**How to contact Alfa Laval**

Contact details for all countries are continually updated on our website. Please visit [www.alfalaval.com](http://www.alfalaval.com) to access the information direct.